

RAIS Visio Gas 40-55-90 T-6541

Visio7_Tunnel_020720

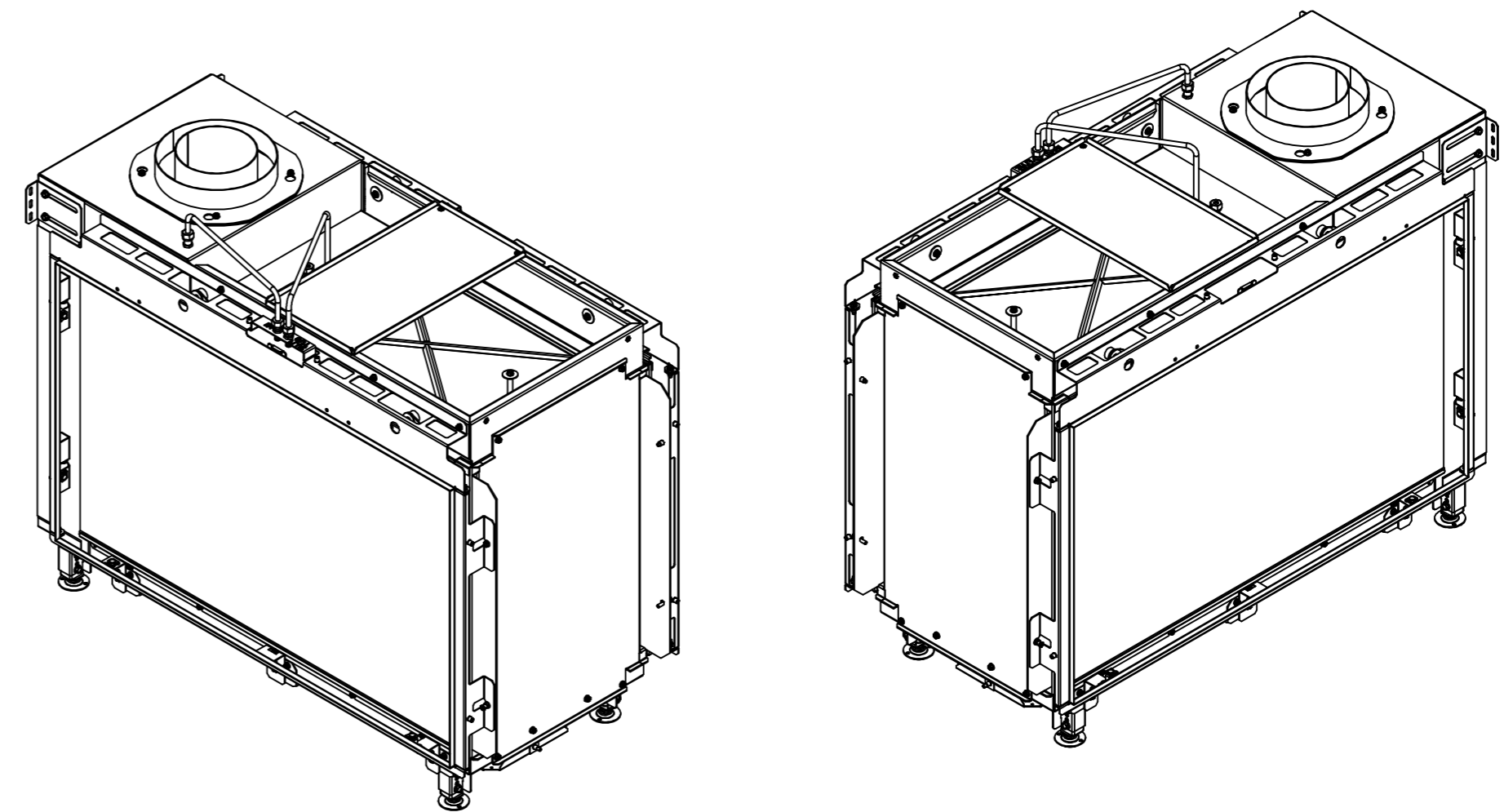
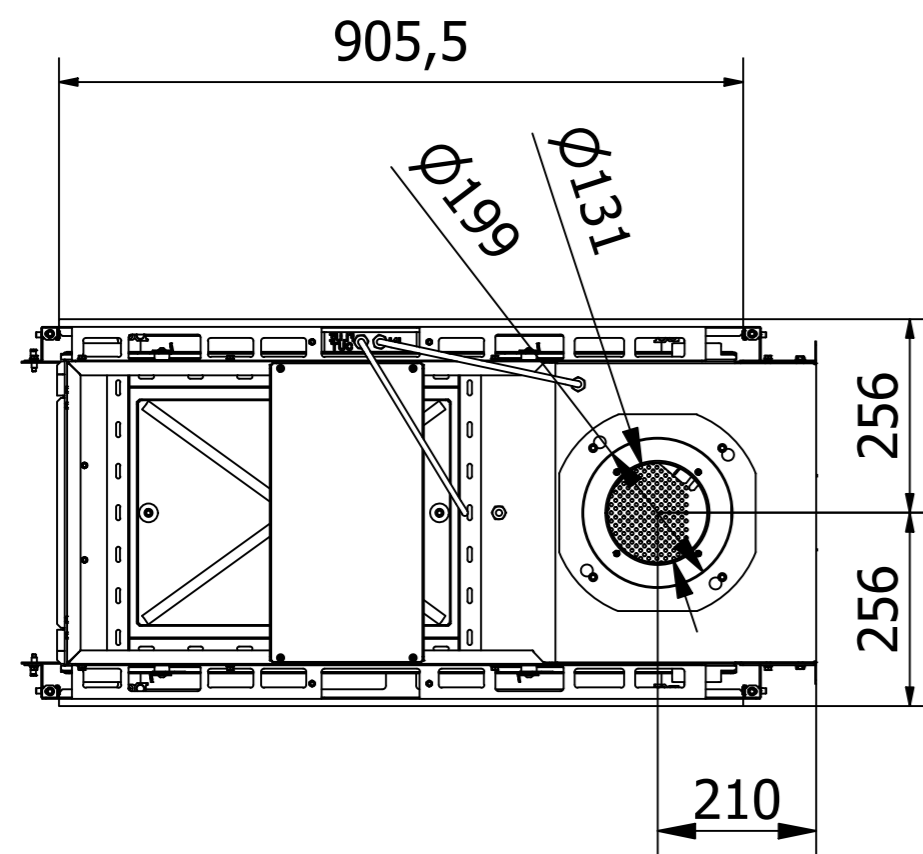
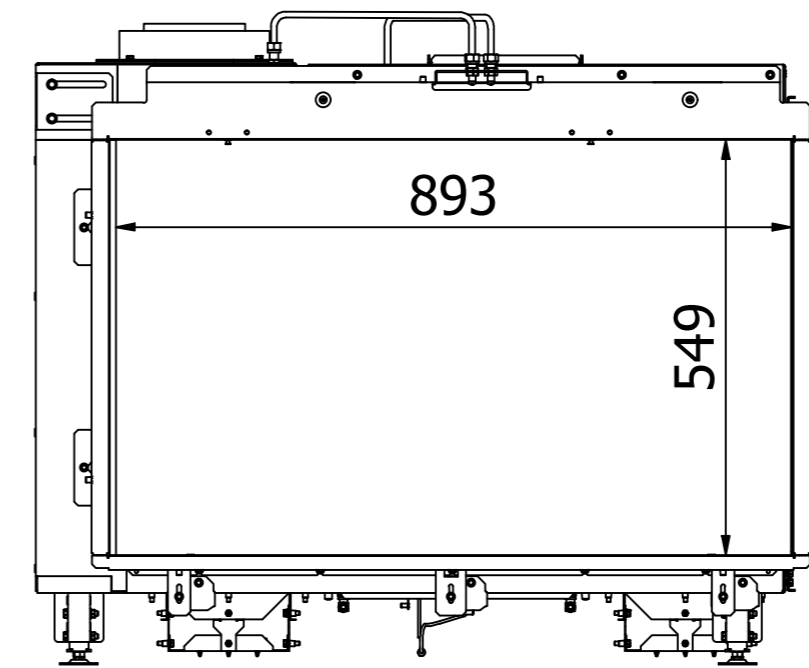
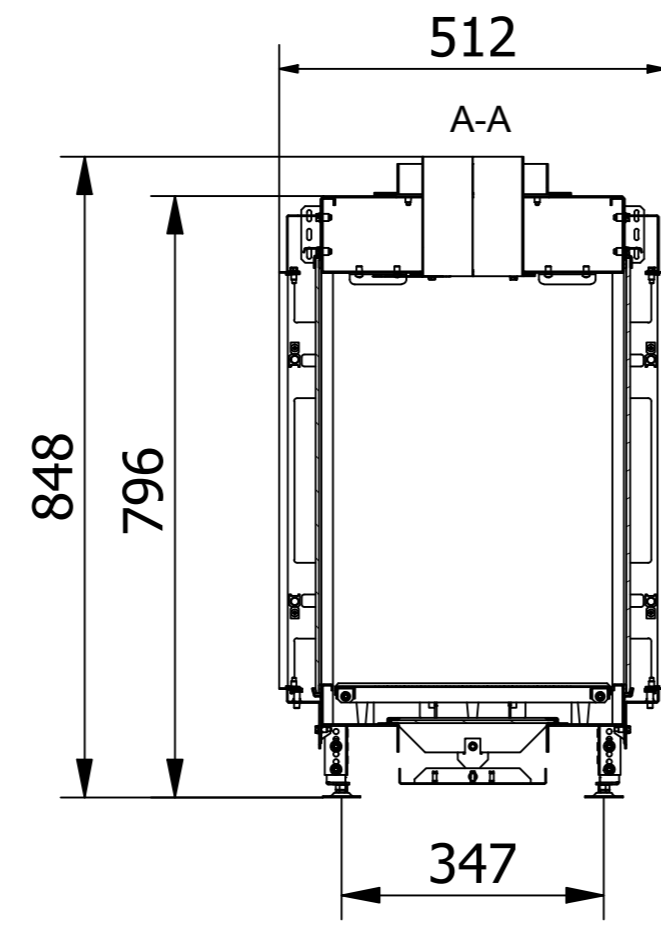
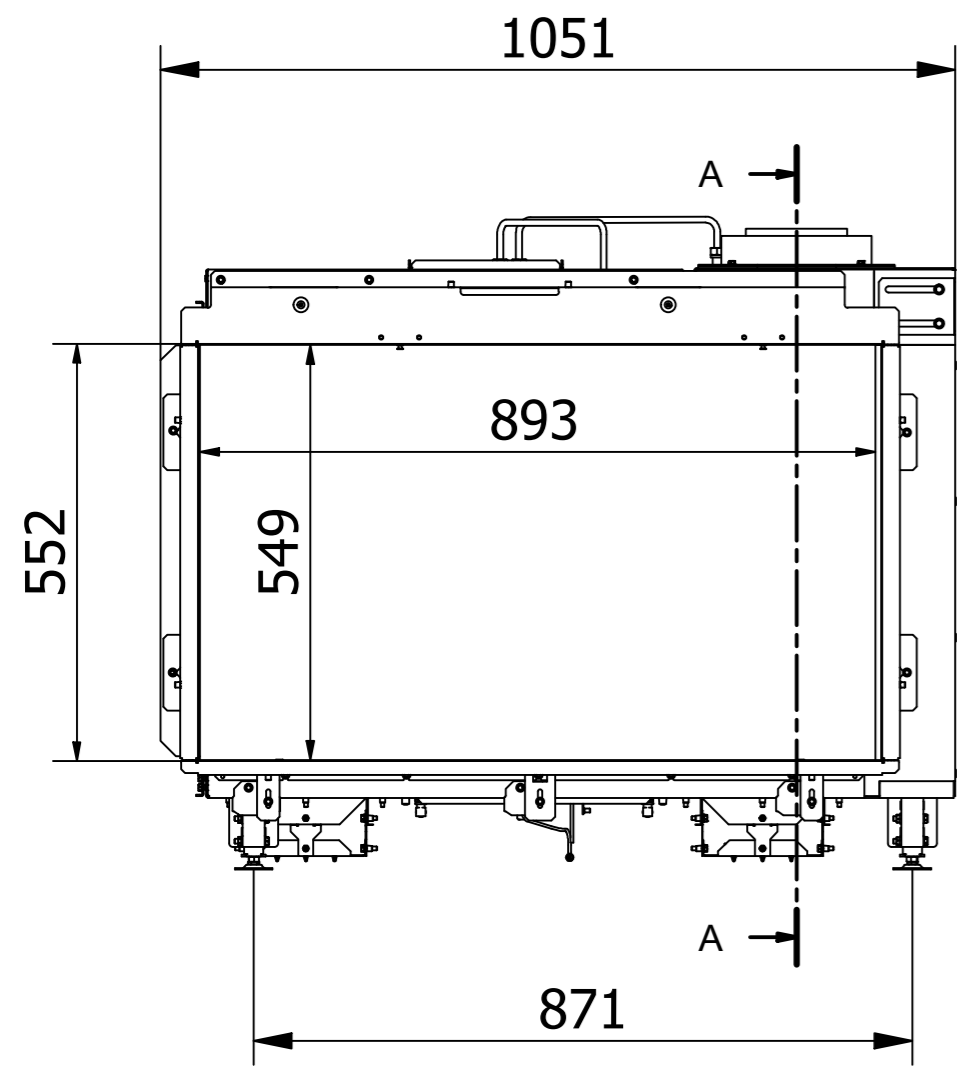

RAIS Visio Gas 40-55-90 T-6543

Visio7_Tunnel_020720

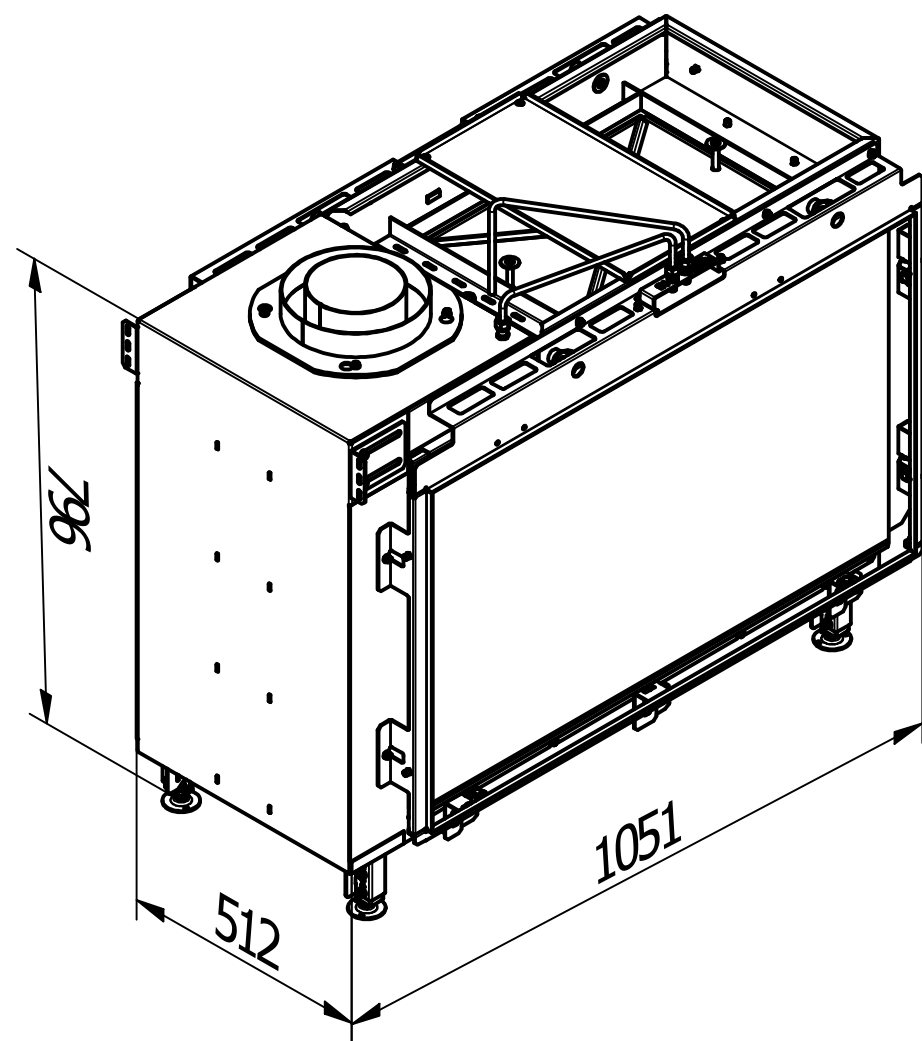

Without frame

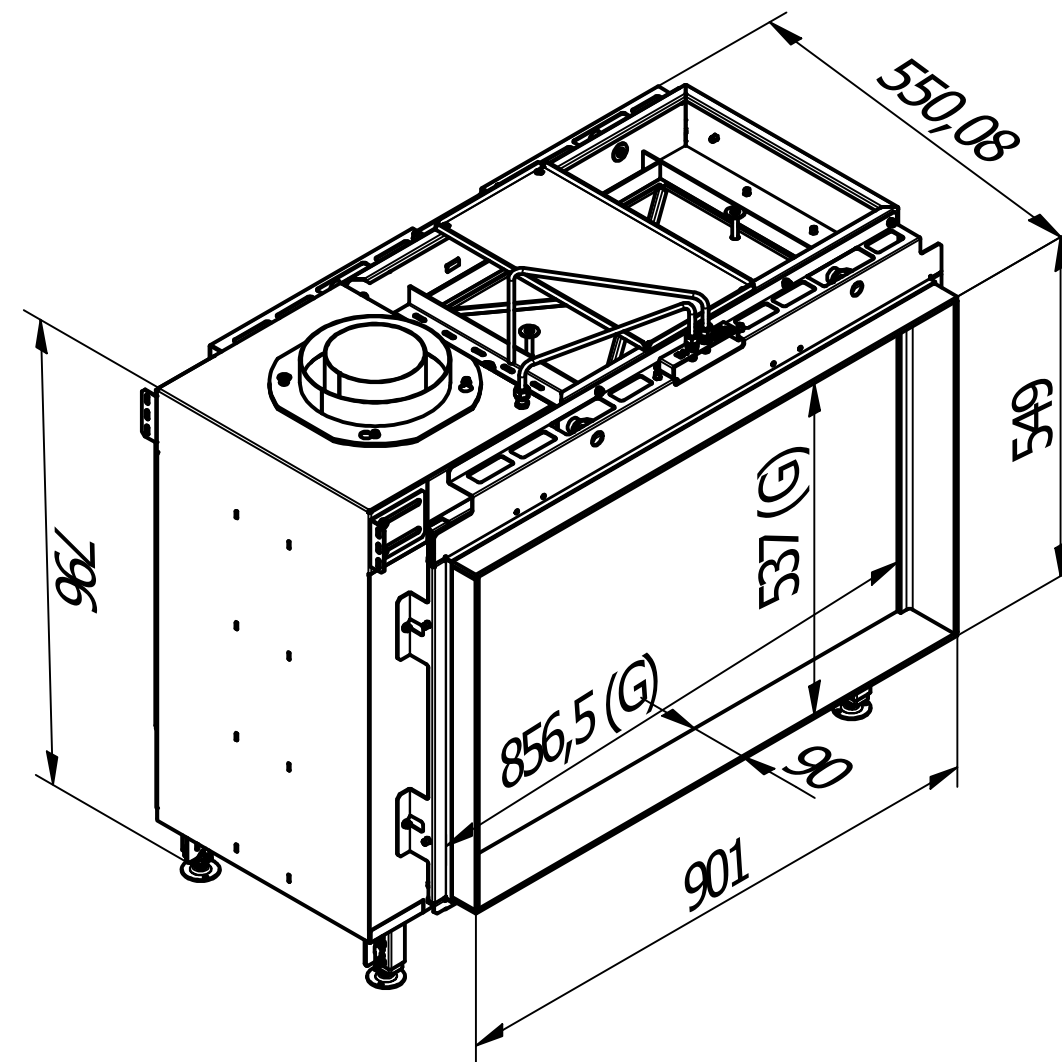

With frame

Recommended free
convection openings
min. 200 cm²

